

# Leica DISTO™ D210

The original laser distance meter



- when it has to be **right**

*Leica*  
Geosystems

<b>Instrument Set-up</b> .....	2
Overview .....	2
Display .....	2
Insert batteries .....	2
<b>Operations</b> .....	3
Switching ON/OFF .....	3
Clear .....	3
Message Codes .....	3
Adjusting measuring reference .....	3
Multifunctional endpiece .....	3
Unit setting .....	3
Beep ON/OFF .....	4
Illumination ON/OFF .....	4
Keypad lock ON .....	4
Keypad lock OFF .....	4
<b>Measuring Functions</b> .....	5
Measuring single distance .....	5
Permanent / Minimum-Maximum measuring .....	5
Add / Subtract .....	5
Area .....	6
Volume .....	6
Memory (last 10 results) .....	6
Delete Memory .....	6
Pythagoras (2-point) .....	7
Pythagoras (3-point) .....	7
Stake out .....	8
<b>Technical Data</b> .....	9
<b>Message Codes</b> .....	9
<b>Care</b> .....	10

<b>Disposal</b> .....	10
<b>Warranty</b> .....	10
<b>Safety Instructions</b> .....	10
Symbols used .....	10
Permitted use .....	10
Prohibited use .....	10
Hazards in use .....	11
Limits of use .....	11
Areas of responsibility .....	11
Electromagnetic Compatibility (EMC) .....	11
Laser classification .....	12
Labelling .....	12

## Overview

 The safety instructions and the user manual should be read through carefully before the product is used for the first time.

 The person responsible for the product must ensure that all users understand these directions and adhere to them.

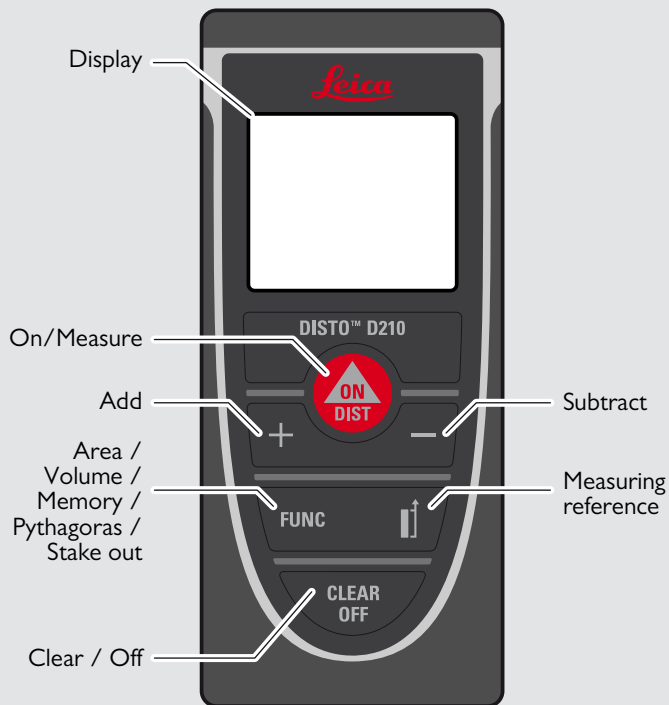

## Display

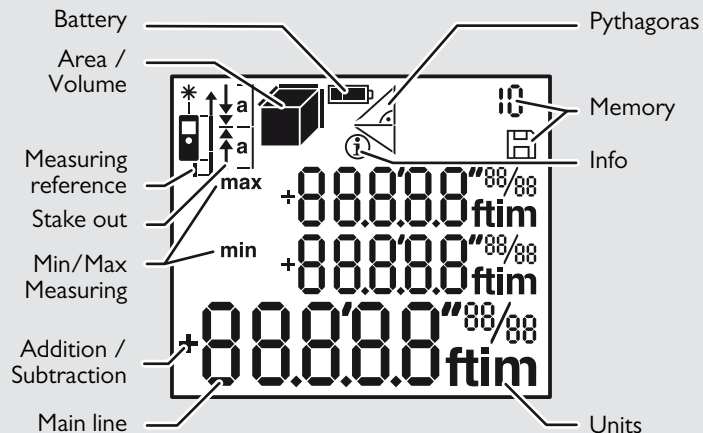

## Insert batteries

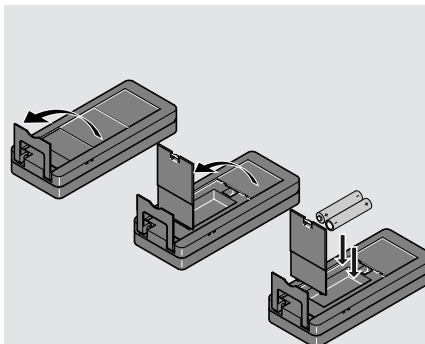

**i**

To ensure reliable use, do not use zinc-carbon batteries. Change batteries when battery symbol is flashing.

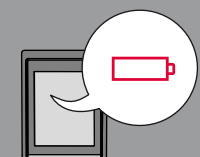

### Switching ON/OFF



**i** Press ON button 2 sec to start continuous laser mode. If no key is pressed for 180 sec, the device switches off automatically.

### Clear

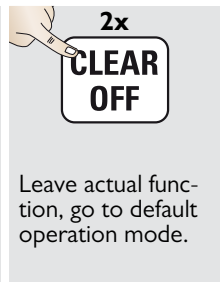
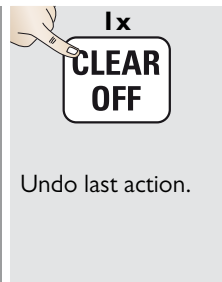

### Message Codes

If the message "InFo" appears with a number, observe the instructions in "Message Codes" section.  
Example:



### Adjusting measuring reference

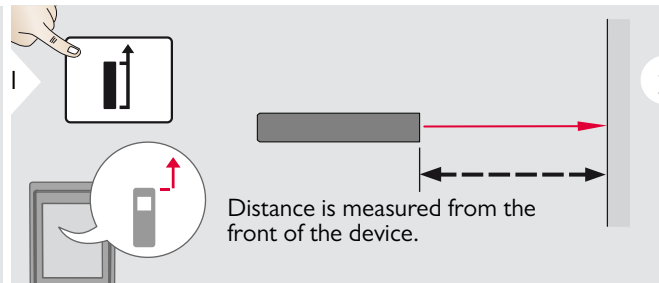

**i** Press button 2 sec and reference from front is set permanently.

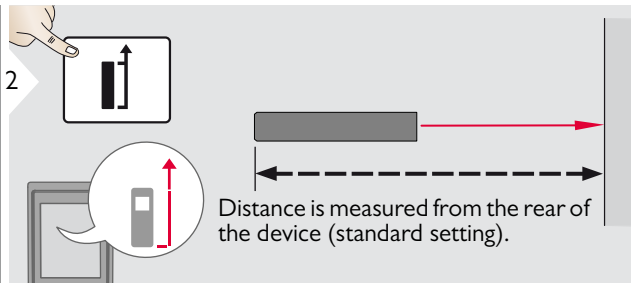

### Multifunctional endpiece

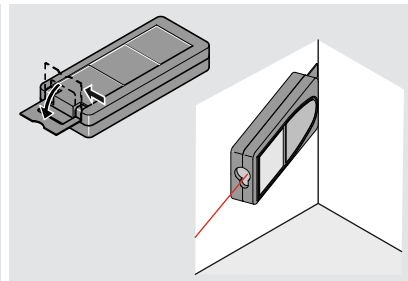
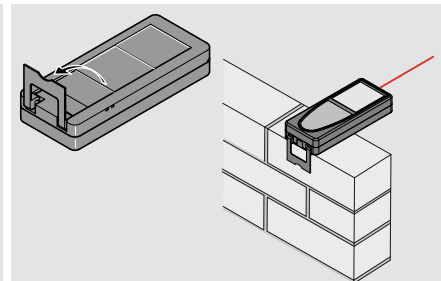

**i** The orientation of the endpiece is automatically detected and the zero point is adjusted accordingly.

### Unit setting

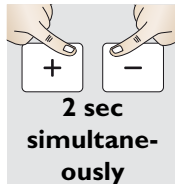

Switch between the following units:

0.000 m	0.00 ft
0.0000 m	0'00" 1/32
0.00 m	0.0 in
	0 in 1/32

**Beep ON/OFF**

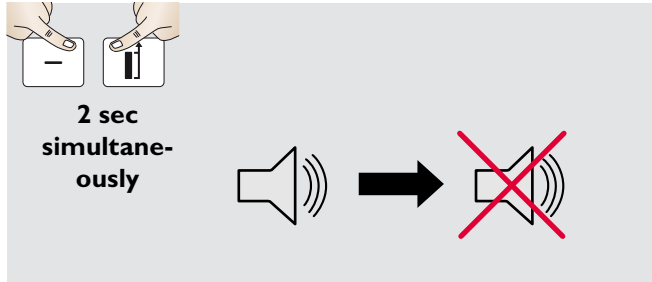

**Illumination ON/OFF**

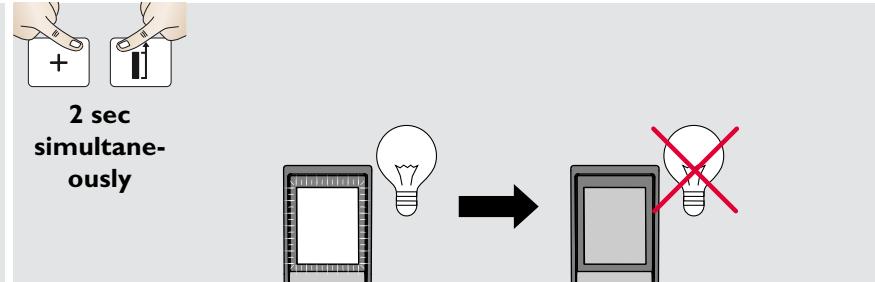

**Keypad lock ON**

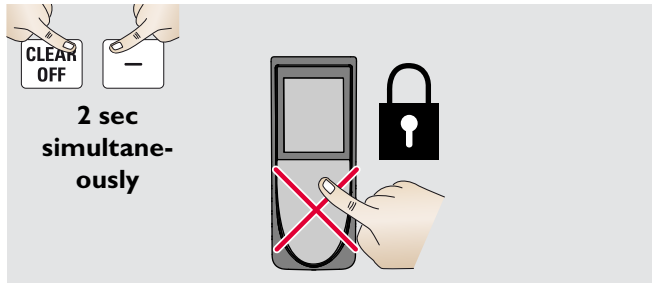

**Keypad lock OFF**

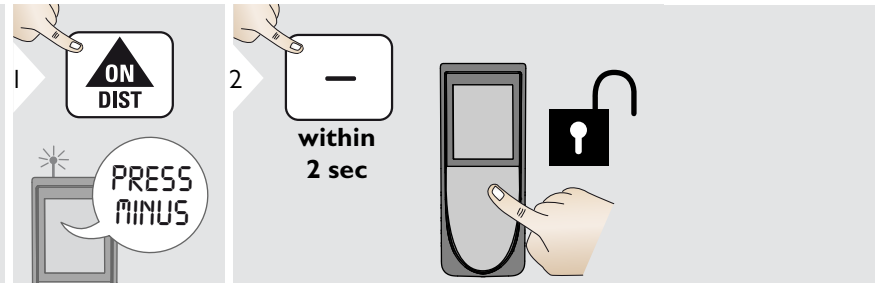

## Measuring single distance

1 **ON DIST**

2 Aim active laser at target.

3 **ON DIST**  
8.532 m

**i** Target surfaces: Measuring errors can occur when measuring to colourless liquids, glass, styrofoam or semi-permeable surfaces or when aiming at high gloss surfaces. Against dark surfaces the measuring time increases.

## Permanent / Minimum-Maximum measuring

1 **ON DIST**  
2 sec

2 min. max.  
Used to measure room diagonals (maximum values) or horizontal distance (minimum values).

3 **ON DIST**  
max  
min  
8.532 m

The minimum and maximum distance measured is displayed (min, max.). The last value measured is displayed in the main line.

**i** Stops permanent / minimum-maximum measuring.

## Add / Subtract

1 **ON DIST**  
7.332 m

2 **+** **-**  
The next measurement is added to the previous one. The next measurement is subtracted from the previous one.

3 **ON DIST**  
7.332 m  
12.847 m

**i** The result is shown in the main line and the measured value above. This process can be repeated as required. The same process can be used for adding or subtracting areas or volumes.

## Area

1 **1x**  
**FUNC**

2 Aim laser at first target point.

3 **ON DIST**

4 Aim laser at second target point.

5 **ON DIST**  
24.352 m<sup>2</sup>

**i**

The result is shown in the main line and the measured value above.

Partial Measurements:  
Press + or - after starting the first measurement. Measure and add or subtract distances. Finish with DIST. Measure 2nd length.

## Volume

1 **2x**  
**FUNC**

2 Aim laser at first target point.

3 **ON DIST**

4 Aim laser at second target point.

5 **ON DIST**

6 Aim laser at third target point.

7 **ON DIST**  
78.694 m<sup>3</sup>

## Memory (last 10 results)

1 **3x**  
**FUNC**  
1...10  
8.294 m

Last 10 values are displayed.

2 **+** **-**  
1...10  
8.294 m

Navigates through last 10 values.

## Delete Memory

3 **CLEAR OFF** **FUNC**  
2 sec  
simultaneously  
Memory is completely deleted.

## Pythagoras (2-point)

1 **4x**  
**FUNC**

2 Aim laser at upper point.

3 **ON**  
**DIST**

4 Aim laser rectangular at lower point.

5 **ON**  
**DIST**  
8.294 m

**i** The result is shown in the main line and the measured distance above.  
Pressing the measuring key for 2 sec in the function activates automatically Minimum or Maximum measurement.

## Pythagoras (3-point)

1 **5x**  
**FUNC**

2 Aim laser at upper point.

3 **ON**  
**DIST**

4 Aim laser at rectangular point.

5 **ON**  
**DIST**

6 Aim laser at lower point.

7 **ON**  
**DIST**  
8.294 m

**i** The result is shown in the main line and the measured distance above.  
Pressing the measuring key for 2 sec in the function activates automatically Minimum or Maximum measurement.



## Stake out

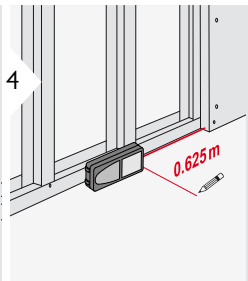
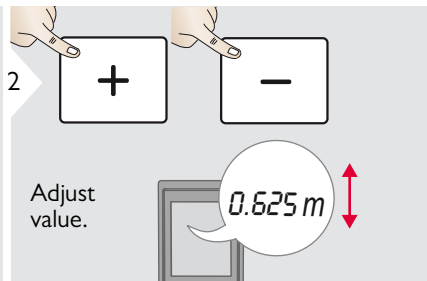
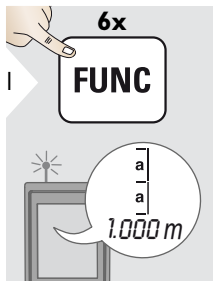
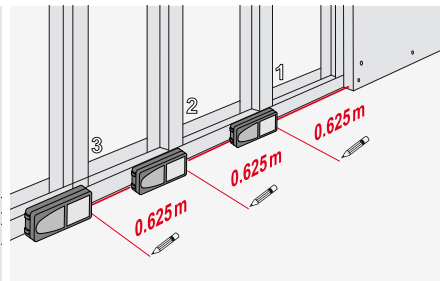

Move device slowly along the stake-out line. The distance to the next stake out point is displayed.

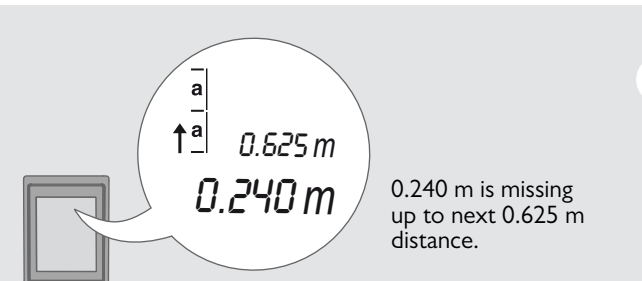

**i** When approaching a stake out point to less than 0.1 m the instrument starts to beep. The function can be stopped by pressing the CLEAR/OFF button.

General	
<b>Typical Measuring Tolerance*</b>	± 1.0 mm / 0.04 in ***
<b>Maximum Measuring Tolerance**</b>	± 2.0 mm / 0.08 in ***
<b>Range at Leica target plate GZM26</b>	100 m / 328 ft
<b>Typical Range*</b>	80 m / 262 ft
<b>Range at unfavourable condition ****</b>	50 m / 164 ft
<b>Smallest unit displayed</b>	0.1 mm / 1/32 in
<b>Power Range Technology™</b>	yes
<b>Laser class</b>	2
<b>Laser type</b>	635 nm, < 1 mW
<b>∅ laser point at distances</b>	6 / 30 / 60 mm 10 / 50 / 100 m
<b>Protection class</b>	IP54 (dust- and splash water protected)
<b>Autom. laser switch off</b>	after 90 s
<b>Autom. power switch-off</b>	after 180 s
<b>Battery durability (2 x AAA)</b>	up to 5000 measurements
<b>Dimension (H x D x W)</b>	114 x 50 x 27 mm 4.49 x 1.97 x 1.06 in
<b>Weight (without batteries)</b>	104 g / 3.34 oz
<b>Temperature range:</b>	
- Storage	-25 to 70 °C -13 to 158 °F
- Operation	-10 to 50 °C 14 to 122 °F

\* applies for 100 % target reflectivity (white painted wall), low ambient light, 25 °C

\*\* applies for 10 to 500 % target reflectivity, high ambient light, - 10 °C to + 50 °C

\*\*\* Tolerances apply from 0.05 m to 10 m with a confidence level of 95%. The maximum tolerance may deteriorate to 0.1 mm/m between 10 m to 30 m and to 0.15 mm/m for distances above 30 m

\*\*\*\* applies for 100 % target reflectivity, ambient light between 10'000 lux and 30'000 lux

Functions	
<b>Distance measuring</b>	yes
<b>Min/Max measuring</b>	yes
<b>Permanent measuring</b>	yes
<b>Stake-out</b>	yes
<b>Addition/Subtraction</b>	yes
<b>Area</b>	yes
<b>Volume</b>	yes
<b>Painter function (area with partial measurem.)</b>	yes
<b>Pythagoras</b>	2-point and 3-point
<b>Memory</b>	10 results
<b>Beep</b>	yes
<b>Illuminated display</b>	yes
<b>Automatic multifunctional endpiece</b>	yes

If the message **Error** does not disappear after switching on the device repeatedly, contact the dealer.

If the message **InFo** appears with a number, press the Clear button and observe the following instructions:

No.	Cause	Correction
204	Calculation error	Perform measurement again.
252	Temperature too high	Let device cool down.
253	Temperature too low	Warm device up.
255	Received signal too weak, measuring time too long	Change target surface (e.g. white paper).
256	Received signal too high	Change target surface (e.g. white paper).
257	Too much background light	Shadow target area.
258	Measurement outside of measuring range	Correct range.
260	Laser beam interrupted	Repeat measurement.

- Clean the device with a damp, soft cloth.
- Never immerse the device in water.
- Never use aggressive cleaning agents or solvents.

## Disposal

### CAUTION

Flat batteries must not be disposed of with household waste. Care for the environment and take them to the collection points provided in accordance with national or local regulations.

The product must not be disposed with household waste.

Dispose of the product appropriately in accordance with the national regulations in force in your country.



Adhere to the national and country specific regulations.

Product specific treatment and waste management can be downloaded from our homepage.

## Warranty

The device comes with a 3-year warranty. To receive the 3-year warranty, the product must be registered on [www.disto.com](http://www.disto.com) within 8 weeks of the purchase date. If the product is not registered, a 2-year warranty applies.

The person responsible for the instrument must ensure that all users understand these directions and adhere to them.

### Symbols used

The symbols used have the following meanings:

#### WARNING

Indicates a potentially hazardous situation or an unintended use which, if not avoided, will result in death or serious injury.

#### CAUTION

Indicates a potentially hazardous situation or an unintended use which, if not avoided, may result in minor injury and/or appreciable material, financial and environmental damage.

 Important paragraphs which must be adhered to in practice as they enable the product to be used in a technically correct and efficient manner.

### Permitted use

- Measuring distances

### Prohibited use

- Using the product without instruction
- Using outside the stated limits
- Deactivation of safety systems and removal of explanatory and hazard labels
- Opening of the equipment by using tools (screwdrivers, etc.)
- Carrying out modification or conversion of the product
- Use of accessories from other manufacturers without express approval
- Deliberate dazzling of third parties; also in the dark
- Inadequate safeguards at the surveying site (e.g. when measuring on roads, construction sites, etc.)
- Deliberate or irresponsible behaviour on scaffolding, when using ladders, when measuring near machines which are running or near parts of machines or installations which are unprotected
- Aiming directly in the sun

## Hazards in use

### WARNING

Watch out for erroneous measurements if the instrument is defective or if it has been dropped or has been misused or modified. Carry out periodic test measurements, particularly after the instrument has been subject to abnormal use, and before, during and after important measurements.

### CAUTION

Never attempt to repair the product yourself. In case of damage, contact a local dealer.

### WARNING

Changes or modifications not expressly approved by Leica Geosystems for compliance could void the user's authority to operate the equipment.

## Limits of use



Refer to section "Technical data".

The device is designed for use in areas permanently habitable by humans. Do not use the product in explosion hazardous areas or in aggressive environments.

## Areas of responsibility

### Responsibilities of the manufacturer of the original equipment:

Leica Geosystems AG  
Heinrich-Wild-Strasse  
CH-9435 Heerbrugg  
Internet: [www.disto.com](http://www.disto.com)

The company above is responsible for supplying the product, including the User Manual in a completely safe condition.

The company above is not responsible for third party accessories.

### Responsibilities of the person in charge of the instrument:

- To understand the safety instructions on the product and the instructions in the User Manual.
- To be familiar with local safety regulations relating to accident prevention.
- Always prevent access to the product by unauthorised personnel.

## Electromagnetic Compatibility (EMC)

### WARNING

The device conforms to the most stringent requirements of the relevant standards and regulations.

However, the possibility of causing interference in other devices cannot be totally excluded.

## Laser classification

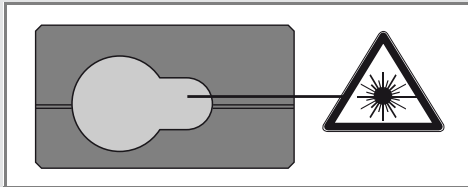

The device produces visible laser beams, which are emitted from the instrument:  
It is a Class 2 laser product in accordance with:

- IEC60825-1 : 2007 „Radiation safety of laser products“

### Laser Class 2 products:

Do not stare into the laser beam or direct it towards other people unnecessarily. Eye protection is normally afforded by aversion responses including the blink reflex.

#### **WARNING**

Looking directly into the beam with optical aids (e.g. binoculars, telescopes) can be hazardous.

#### **CAUTION**

Looking into the laser beam may be hazardous to the eyes.

## Labelling

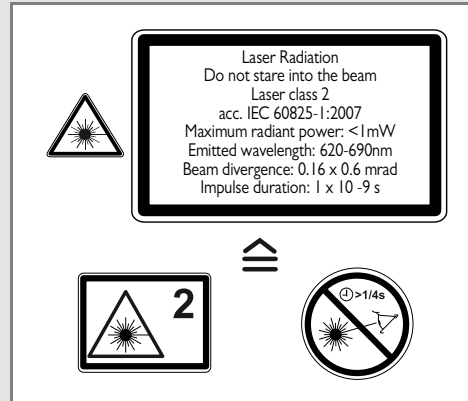

Subject to change (drawings, descriptions and technical data) without prior notice.

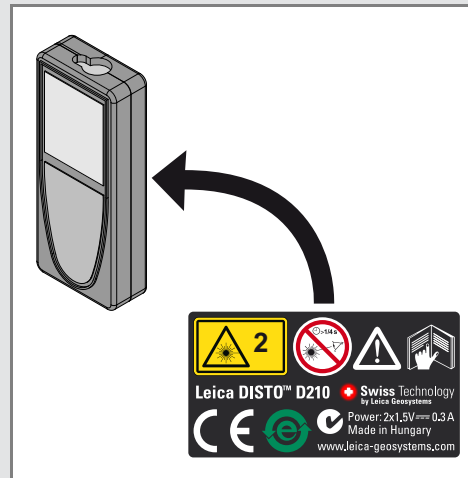



Leica Geosystems AG, Heerbrugg, Switzerland has been certified as being equipped with a quality system which meets the International Standards of Quality Management and Quality Systems (ISO standard 9001) and Environmental Management Systems (ISO standard 14001).

Total Quality Management - Our commitment to total customer satisfaction. Ask your local Leica Geosystems agent for more information about our TQM program.

Copyright Leica Geosystems AG, Heerbrugg,  
Switzerland 2011  
Translation of original text (788217 EN)

Pat. No.: WO 9427164, WO 9818019, WO 0244754, WO 0216964,  
US 5949531, EP 1195617, US 7030969, WO 03104748



Leica Geosystems AG  
CH-9435 Heerbrugg  
(Switzerland)  
[www.disto.com](http://www.disto.com)

- when it has to be **right**

